

ING HO LIMITED
切割夾持專家

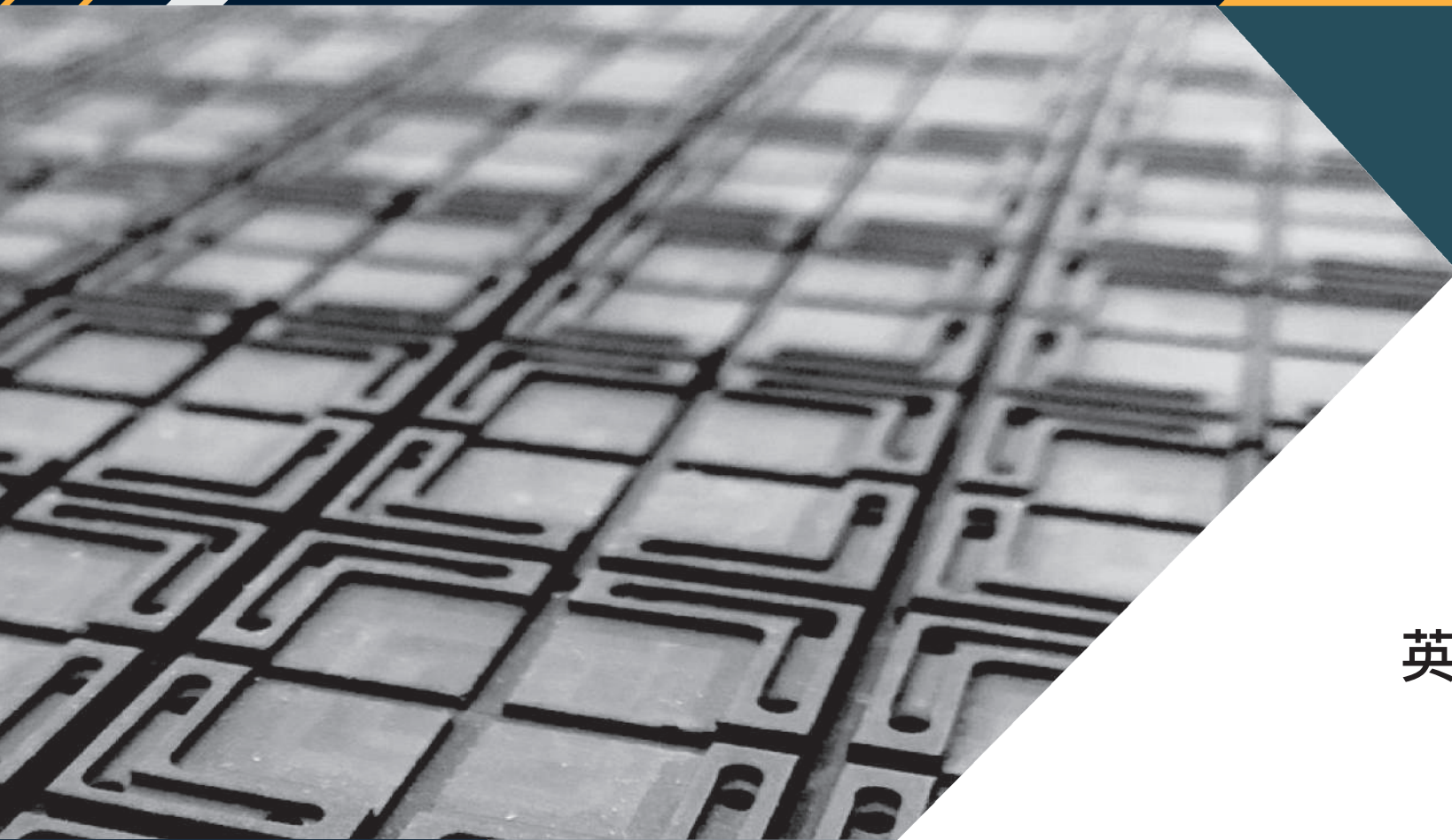

INGHO

英賀有限公司

關於英賀

公司簡介

自創立以來，秉持「研發、效率、創新」的經營理念下穩健成長。

擁有上百組以上切割治具設計製造經驗，可製作各種高難度的切割治具，解決床台切割時真空吸力不足導致切割品質不佳以及排水/破真空...等生產上各式問題。

我們擁有自己的加工廠及加工設備，主力於半導體切割製程治具研發製造及各類精密半導體零件，擁有10多年機械加工及半導體工業經驗，專業服務台灣知名三大載板廠，目前以市佔最高的 HANMI 及 Disco 各型基板切割機台切割治具皆可製作。

治具主要項目

切割床台(切割夾持)
移載平台(切割完成後移動機構)
暫置平台(暫放等待取出)

我們的理念簡單而確定

提供最好的設計及加工、優良的產品、
最優良的服務給我們的客戶。

作業流程

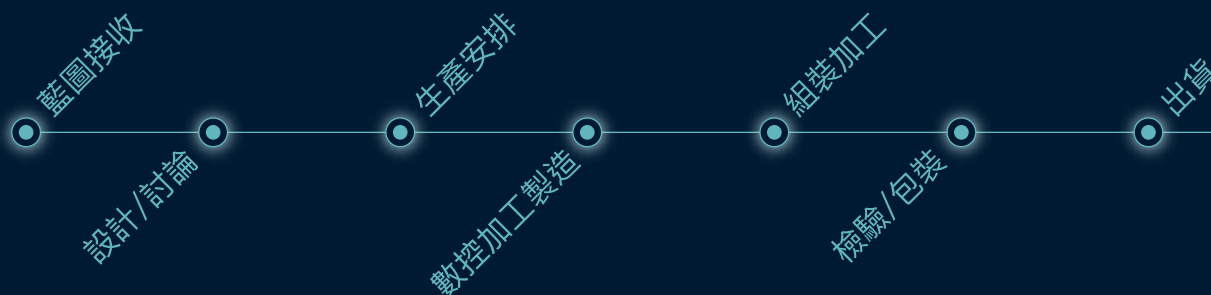

切割治具

JIG SAW

切割床台 (切割真空夾持機構)

- 高真空力
- 超高效物理排水
- 吸附素材不產生型變
- 超強支撐力切割穩定
- 採用 IC 載板專用橡膠，杜絕汙染 / 沾黏
- 多種吸附方式選擇

床台尺寸		
長	寬	高
50~600mm	50~600mm	6~80mm

吸附樣式					
Unite Size					
3~25mm	✓	✗	✗	✗	
26~45mm		✓		✗	
46~60mm	✗	✓	△	✗	
61~75mm	✗	✓	△	✗	
76~100mm	✗	✓	△	✗	

- ✓ 優
- △ 尚可
- ✗ 不建議
-  依實際基板狀況

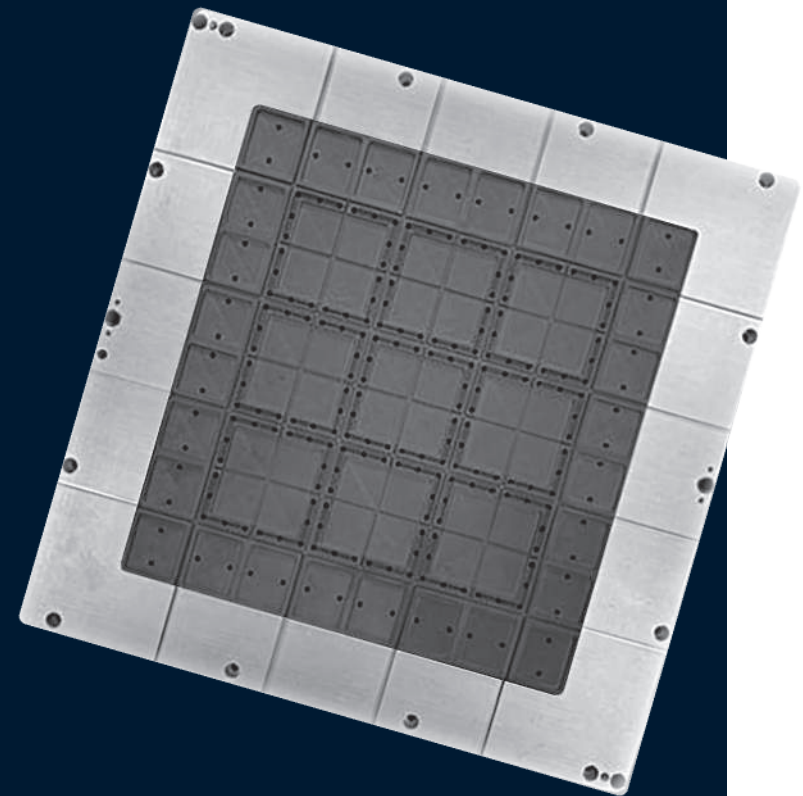

切割治具

移載機構 (切割完成後移動機構)

- 板邊、板內雙管路控制
- 使用低重量的壓克力材質，減少機台負擔
- 高真空值，不掉板
- 吸附時素材不變形
- 採用 IC 載板專用橡膠，杜絕汙染 / 沾黏

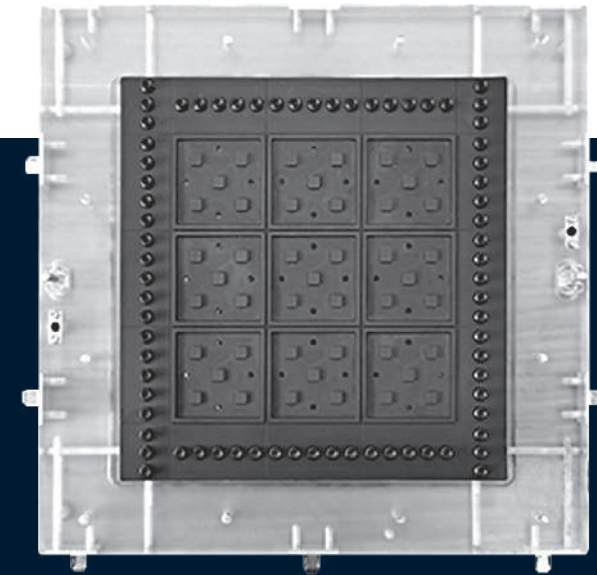

床台尺寸		
長	寬	高
50~600mm	50~600mm	6~80mm

吸附樣式					
Unite Size	☉	└	田	⊗	☰
3~25mm	☑	⊗	⊗	⊗	☑
26~45mm	☑	⊗	☐	☑	☑
46~60mm	△	⊗	△	☑	☑
61~75mm	⊗	⊗	△	☑	☑
76~100mm	⊗	⊗	△	☑	☑

- ☑ 優
- △ 尚可
- ⊗ 不建議
- ☐ 依實際基板狀況

JIG SAW

暫置平台 (暫放等待取出機構)

- 高真空力
- 深孔排水系統
- 多樣吸附方式
- 吸附時素材不變形
- 採用 IC 載板專用橡膠，杜絕汙染 / 沾黏

吸附樣式

Unite Size	☐	└	田	⊗	≡
3~25mm	✓	✗	✗	✗	△
26~45mm	△	✓	☐	☐	△
46~60mm	✗	✓	△	△	△
61~75mm	✗	✓	△	△	△
76~100mm	✗	✓	△	△	△

- ✓ 優
- △ 尚可
- ✗ 不建議
- ☐ 依實際基板狀況

床台尺寸

長	寬	高
50~600mm	50~600mm	6~80mm

JIG SAW

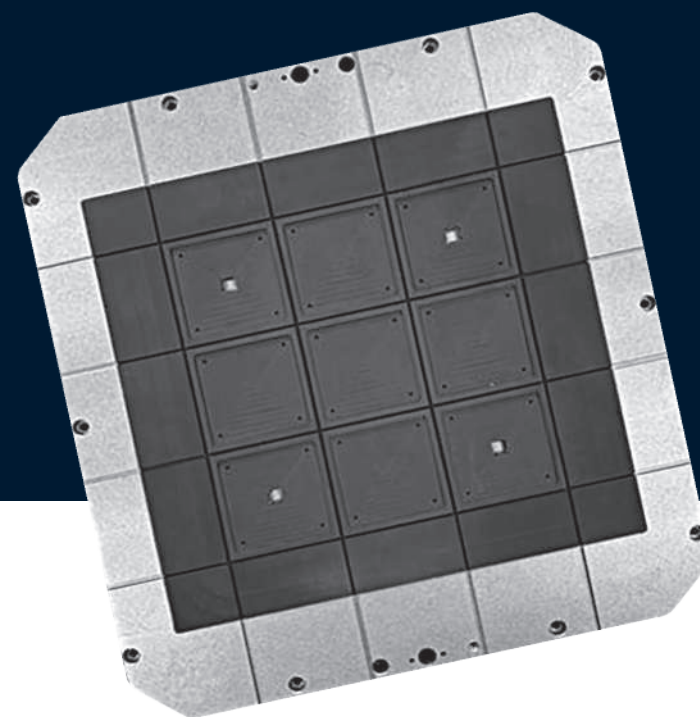





切割治具

吸嘴 (各類吸盤)

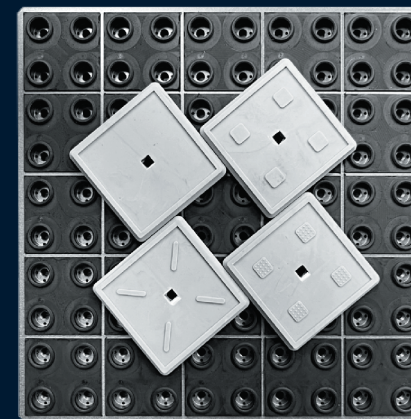
床台尺寸		
長	寬	高
10~100mm	10~100mm	3~50mm

Unite Size	吸附樣式			
				
3~25mm				
26~45mm				
46~60mm				
61~75mm				
76~100mm				



-  優
-  尚可
-  不建議
-  依實際基板狀況

專業檢測

高倍率放大鏡直線度檢測

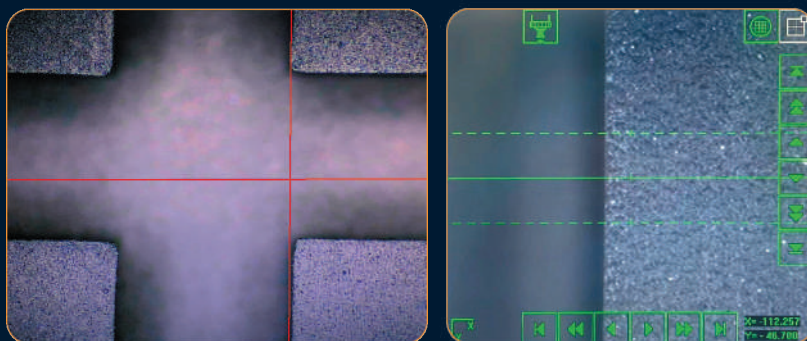

平面檢測



零配件

配件及耗材

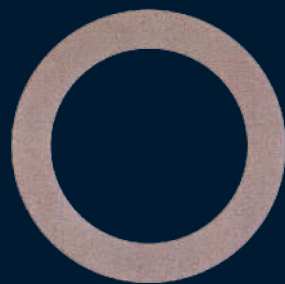

金屬刀
MetalBond Blade

高剛性 高壽命

- 結合劑種類豐富，適用於各種半導體封裝組件如 BGA 類及玻璃與石英切割
- 刀刃超薄 (45um以上)



電鑄鎳刀
Electro-formed Nickel Bond Blade

高質量 低磨耗

- 精密的電鑄技術
- 多樣化結合劑可對應於各種不同工件材料
- 獨家研發和客製化技術

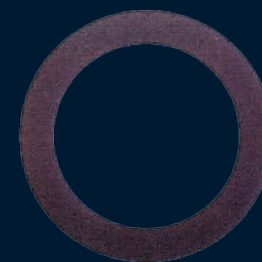

樹脂刀
ResinBond Blade

自我再生特性

- 降低對於具延展性及黏性材料的切割加工毛邊 (Burr) 及側邊拉絲間隙 (Smear clearance)
- 改善對於硬脆材料的切削加工崩邊，進刀速度與刀片壽命
- 刀刃超薄 (50um以上)



研磨盤

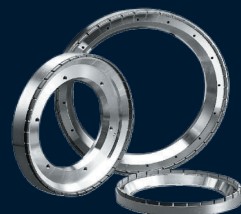

晶圓研磨輪



研磨板

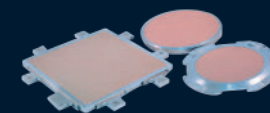

專用陶瓷盤 chuck table



統編 28497831

電話 +886-2-89916086

傳真 +886-2-29951619

E-mail service@ingho.com.tw

www.ingho.com.tw

241 新北市三重區光復路一段30巷4號